

**IMPORTANT  
SAFETY RULES**  
Read, Understand, and Follow all  
Instructions Carefully before  
Installing and using this Product.

# Ultra Frame™ Pool

16' - 18' (488 cm - 549 cm) models



For illustrative purposes only. Accessories may not be provided with pool.

**Don't forget to try these other fine Intex products: Pools, Pool Accessories, Inflatable Pools and In-Home Toys, Airbeds and Boats available at fine retailers or visit our website.**



©2006 Intex Marketing Ltd. - Intex Development Co. Ltd. - Intex Recreation Corp.  
All rights reserved/Tous droits réservés/Todos los derechos reservados/Alle  
Rechte vorbehalten.

Printed in China/Imprimé en Chine/Impreso en China/Gedruckt in China.  
®™ Trademarks used in some countries of the world under license from/®™ Marques utilisées dans certains pays sous  
licence de/Marcas registradas utilizadas en algunos países del mundo bajo licencia de/Warenzeichen verwendet in einigen  
Ländern der Welt in Lizenz von/Intex Marketing Ltd. to/à/a/an Intex Development Co. Ltd., 8th Floor, Dah Sing  
Financial Centre, 108 Gloucester Road, Wanchai, Hong Kong & Intex Recreation Corp., P.O. Box 1440, Long Beach,  
CA 90801 • Distributed in the European Union by/Distribué dans l'Union Européenne par/Distribuido en la unión Europea  
por/Vertrieb in der Europäischen Union durch/Intex Trading B.V., P.O. Box nr. 1075 - 4700 BB Roosendaal - The  
Netherlands

# TABLE OF CONTENTS

**Warnings..... 3**

**Parts List & Reference..... 4-6**

**Set Up Instructions..... 7-9**

**Pool Maintenance and Chemicals..... 10-11**

**Common Pool Problems..... 10**

**Pool Draining..... 11**

**Storage..... 11-12**

**General Aquatic Safety..... 13**

**Intex Service Center Locations..... 14**

**Introduction:**

*Thanks for buying an Intex pool. Please take a few minutes to read this manual before setting up your pool. This information will help extend the pool life and make the pool safer for your family's enjoyment. View the video included before installation. A team of 2-3 people is recommended for pool set up. Additional people will speed up the installation.*

**IMPORTANT SAFETY RULES**

Read, Understand and Follow All Instructions Carefully Before Installing and Using this Product.

**⚠ WARNING**

- **Continuous and competent adult supervision of children and the handicapped is required at all times.**
- Secure all doors, windows and safety barriers to prevent unauthorized, unintentional or unsupervised pool entry.
- Install a safety barrier that will eliminate access to the pool for young children and pets.
- Pool and pool accessories are to be assembled and disassembled by adults only.
- Never dive, jump or slide into an above-ground pool or any shallow body of water.
- Failure to set up pool on flat, level, compact ground could result in the pool's collapse or the possibility that a person lounging in the pool could be swept out.
- Do not lean, straddle, or exert pressure on the inflatable ring or top rim as injury or flooding could occur. Do not allow anyone to sit on, climb, or straddle the sides of the pool.
- Remove all toys and flotation devices from, in and around the pool when it is not in use. Objects in the pool attract young children.
- Keep toys, chairs, tables, or any objects that a child could climb on at least four feet away from the pool.
- Keep rescue equipment by the pool and clearly post emergency numbers at the phone closest to the pool. Examples of rescue equipment: coast guard approved ring buoy with attached rope, strong rigid pole not less than twelve feet (12') [365.76cm] long.
- Never swim alone or allow others to swim alone.
- Keep your pool clean and clear. The pool floor must be visible at all times from the outside barrier of the pool.
- If swimming at night use artificial lighting to illuminate all safety signs, ladders, pool floor and walkways.
- Stay away from the pool when using alcohol or drugs.
- Keep children away from pool covers to avoid entanglement, drowning, or other serious injury.
- Pool covers must be completely removed before pool use. Children and adults cannot be seen under a pool cover.
- Do not cover or uncover the pool while you or anyone else is in the pool.
- Keep the pool and pool area clean and clear to avoid slips and falls and objects that may cause injury.
- Protect all pool occupants from recreational water illnesses by keeping the pool water clean. Don't swallow the pool water. Practice good hygiene.
- Pools are subject to wear and deterioration. Properly maintain your pool. Certain types of excessive or accelerated deterioration can lead to pool failure. Pool failure might cause large quantities of water to release from the pool.
- This pool is for outdoor use only.
- Empty and store when not in use.

**POOL BARRIERS AND COVERS ARE NOT SUBSTITUTES FOR CONTINUOUS AND COMPETENT ADULT SUPERVISION.**









**FAILURE TO FOLLOW THESE WARNINGS MAY RESULT IN PROPERTY DAMAGE, SERIOUS INJURY OR DEATH.**

**Advisory:**

Pool owners may need to comply with local or state laws relating to childproof fencing, safety barriers, lighting, and other safety requirements. Customers should contact their local building code enforcement office for further details.

# PARTS LIST

## PARTS LIST

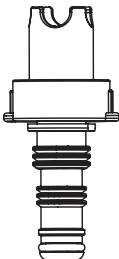
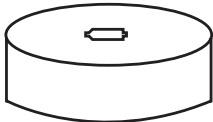
1 	2 	3 
4 	5 	6 
7 	8 	9 
10 		

**NOTE:** Drawings for illustration purpose only. May not reflect actual product. Not to scale.

### PARTS REFERENCE

Before assembling your product, please take a few minutes to check the contents and become familiar with all the parts.

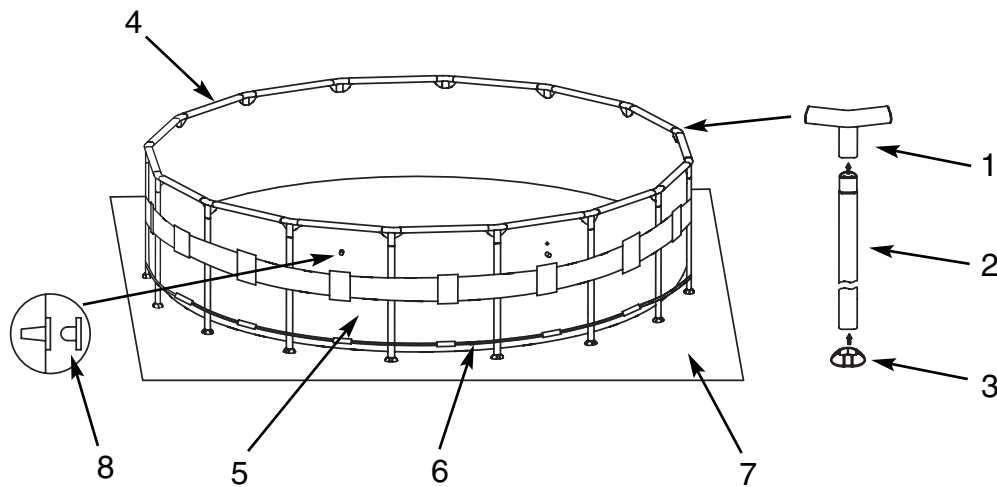

**NOTE:** Drawings for illustration purpose only. May not reflect actual product. Not to scale.

16' (488 cm) model

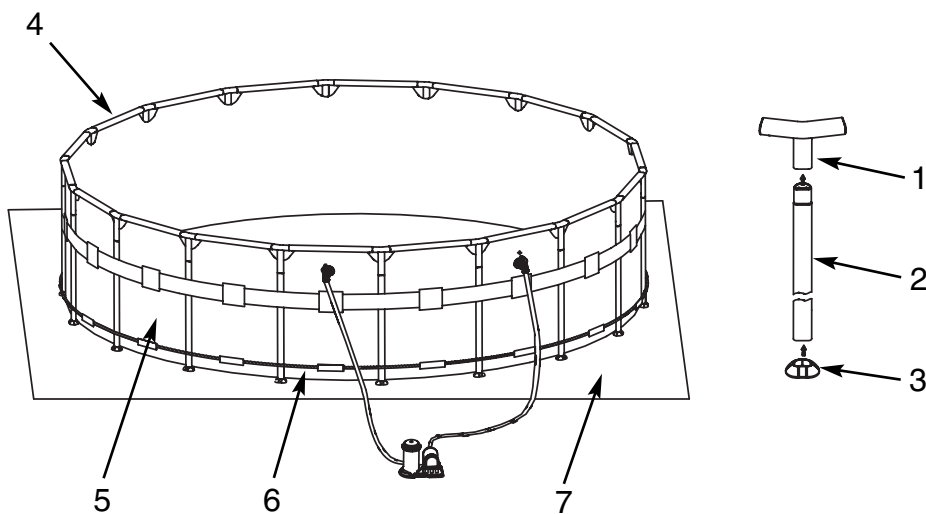

**NOTE:** Drawings for illustration purpose only. May not reflect actual product. Not to scale.

18' (549 cm) model

**PARTS REFERENCE**

REF NO.	DESCRIPTION	POOL SIZE & QUANTITY	
		16' (488cm)	18' (549cm)
1	T - JOINT	16	18
2	VERTICAL LEG	16	18
3	LEG CAP	16	18
4	HORIZONTAL BEAM	16	18
5	POOL LINER (DRAIN VALVE CAP INCLUDED)	1	1
6	RESTRAINING ROPE	1	1
7	GROUND CLOTH	1	1
8	STRAINER HOLE PLUG (WITH 1 EXTRA)	3	
9	DRAIN CONNECTOR	1	1
10	DRAIN VALVE CAP	1	2

REF NO.	DESCRIPTION	16' x 48"	18' x 52"
		(488cm x 122cm)	(549cm x 132cm)
		SPARE PART NO.	
1	T - JOINT	10982	10983
2	VERTICAL LEG	10981	10981
3	LEG CAP	10984	10984
4	HORIZONTAL BEAM	10980	10980
5	POOL LINER (DRAIN VALVE CAP INCLUDED)	10988	10989
6	RESTRAINING ROPE	10317	10317
7	GROUND CLOTH	18927	18933
8	STRAINER HOLE PLUG (WITH 1 EXTRA)	10127	
9	DRAIN CONNECTOR	10201	10201
10	DRAIN VALVE CAP	10649	11044

PARTS REFERENCE

## POOL SET UP

### IMPORTANT SITE SELECTION AND GROUND PREPARATION INFORMATION

#### WARNING

- The pool location must allow you to secure all doors, windows, and safety barriers to prevent unauthorized, unintentional or unsupervised pool entry.
- Install a safety barrier that will eliminate access to the pool for young children and pets.
- Failure to set up the pool on flat, level, compact ground and in accord with the following instructions could result in the pool's collapse or the possibility that a person lounging in the pool could be swept out, resulting in serious injury or property damage.
- Risk of electric shock: connect the filter pump only to a grounding type receptacle protected by a ground-fault circuit interrupter (GFCI). To reduce risk of electric shock, do not use extension cords, timers, plug adapters or converter plugs to connect the pump to electric supply; provide a properly located outlet. Locate cord where it will not be damaged by lawn mowers, hedge trimmers, and other equipment. See Filter Pump manual for additional warnings and instructions.

#### Select an outdoor location for the pool with the following in mind:

1. The area where the pool is to be set up must be **absolutely flat and level**.  
Do not set up the pool on a slope or inclined surface.
2. The ground surface must be compacted and firm enough to withstand the pressure and weight of a fully set up pool. **Do Not** set up the pool on mud, sand, soft or loose soil conditions.
3. **Do Not** set up the pool on a deck or platform.
4. The pool requires at least 4 feet of space all around pool from objects that a child could climb on to gain access to the pool.
5. Pool will kill the grass. Splash out could damage vegetation. Certain types of grass such as St. Augustine and Bermuda, may grow through the liner.

**POOL SET UP (continued)**

This pool may have been purchased with the Intex Krystal Clear™ filter-pump. The filter-pump has a separate set of installation instructions and is to be set-up after assembling this unit.

- Find a flat, level location that is free and clear of stones, branches or other sharp objects that may puncture the pool liner or cause injury.
- Open the carton containing the liner, joints, legs, etc., very carefully as this carton can be used to store the pool during the winter months.

- Remove the ground cloth (**7 optional**) and spread over the area cleared, and then remove the liner (**5**) and spread it out over the ground cloth with the drain valve towards the draining area. Place the drain valve away from the house. Allow the sun to warm up the liner before inserting the beams (**4**) into the sleeve openings.

**IMPORTANT: Do not drag the pool liner across the ground as this may result in leaks or other damage (see drawing 1).**

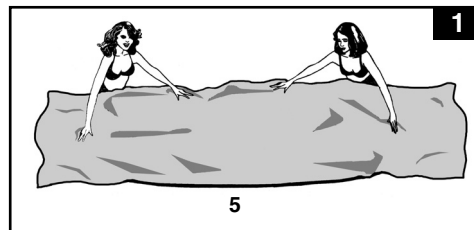

- During the set-up of this pool liner point the hose connections or openings in the direction of the electric power source. The outer edge of the assembled pool is to be within reach of the electrical connection for the optional filter-pump.

- The frame pool's legs (**2**) and beams (**4**) fall into two groups. The smaller diameters are the vertical legs. Both these legs and beams fit into the T-joints (**1**).

- Starting at any location, but always working in the same direction, push the horizontal beam into the sleeve (see drawing 2.1). Once the beam is centered take one of the T-joints (**1**), snap the joint to one end of the beam by aligning the hole and the spring-loaded pin. Repeat this procedure in a circular fashion until all the beams and joints have been connected (see drawing 2.2).

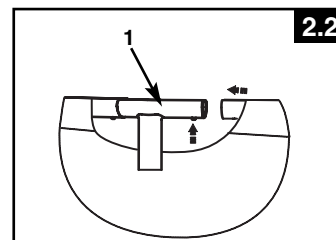
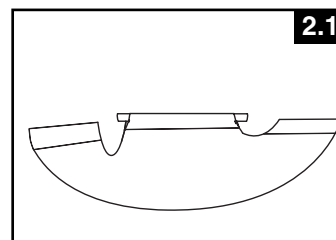

The last joint connection may be difficult to complete, but can be easily done by simultaneously raising this last joint and beam about 2 inches (5 cm), and connect the beam to the joint while lowering these pieces to their normal position. The joint will slide into the beam (see drawing 2.3). Make sure the last joint is fully assembled before proceeding to assembling the legs.

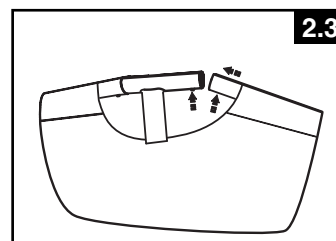

## POOL SET UP (continued)

3. Next slide the vertical legs into the belt loop located in the middle of the pool liner. The bottom of the leg is to be "inside" the white restraining rope (6) located near the liner's bottom edge. Carefully slide the leg into the belt loop and place the leg's bottom inside the rope and then insert the top of the leg into the bottom of the joint. Snap this leg into joint's holes by aligning the hole and the spring-loaded pin. Attach the leg's end cap (3) to the bottom of the leg (see drawing 3).

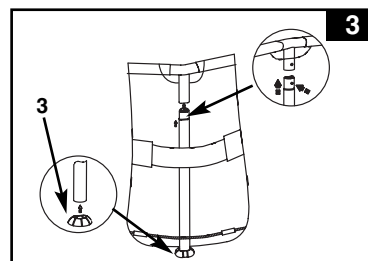

4. • Grab the frame pool's top beams in 2 – 3 locations and "shake" the pool to be sure all the joints, legs and beams "fit into each other".
- Pull gently, in an outward direction, at the bottom of the leg making sure the leg is inside the restraining rope. The leg is to end up in an upright vertical position.
5. For pool liner **with** hose connectors (16' (488 cm) & below pools), if pool was purchased **without** a filter pump, use two of the three plugs (8) and plug them into the black filter pump outlets from the inside of the pool so water will not run out while filling. **If pool was purchased with a filter pump, see Krystal Clear™ Filter Pump Manual first and then go to step #6.**
6. • Before starting to fill pool with water, check to be sure that the drain plug inside the pool is closed and the drain cap on the outside is screwed on tightly. Fill the pool with no more than 1 inch of water; and look to see if there is any noticeable difference in the slope of the pool floor.

**IMPORTANT: If the water in the pool flows to one side, the pool is not completely level. Setting up the pool on unlevel ground will cause the pool to tilt resulting in the sidewall material bulging. If the pool is not completely level, you must drain the pool, level the area or move the pool to a different area that is level, and re-fill the pool.**

- Begin to smooth out the remainder of wrinkles (from inside pool) by pushing out where the pool floor and pool sides meet, or (from outside pool) reach under the pool side, grasp the pool floor and pull out. If the ground cloth is causing the wrinkles then have 2 adults pull from either side to remove all wrinkles.

7. Water may be filled up to 4" (10 cm) from the top (see drawing 4).

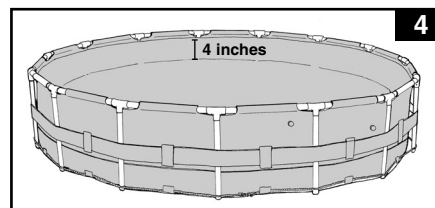

## IMPORTANT

Before allowing anyone to use the pool, hold a family meeting and establish a set of rules that include, at a minimum, the important safety rules and general aquatic safety information in this manual. Review these rules on a regular basis and with all users of the pool including guests.

## POOL MAINTENANCE & CHEMICALS

### ⚠ WARNING

#### REMEMBER TO

- Protect all pool occupants from recreational water illnesses by keeping the pool water clean. Don't swallow the pool water. Practice good hygiene.
- Keep your pool clean and clear. The pool floor must be visible at all times from the outside barrier of the pool.
- Keep children away from pool covers to avoid entanglement, drowning, or other serious injury.

The maintenance of proper water balance is the single most important factor to maximize the life and appearance of the liner as well as ensuring clean, healthy, safe water. Proper technique is important for water testing. See your pool professional for chemical, test kits and testing procedures. Be sure to read and follow the written instructions from the chemical manufacturer.

1. Never let chlorine come into contact with the liner before the chlorine has fully dissolved. Granular or tableted chlorine is dissolved first into a bucket of water. Likewise, liquid chlorine, if poured into various locations around the pool, must be immediately mixed thoroughly with pool water.
2. Never mix chemicals together, rather add chemicals to pool water separately and circulate throughout pool before adding additional chemicals.
3. An Intex pool skimmer and an Intex pool vacuum are available to assist in maintaining clean pool water. See your pool dealer for these pool accessories.
4. Do not use pressure washer to clean the pool.

PROBLEM	DESCRIPTION	CAUSE	REMEDY
<b>ALGAE</b>	<ul style="list-style-type: none"> <li>• Greenish water.</li> <li>• Green or black spots on pool liner.</li> <li>• Pool liner is slippery and/or has a bad odor.</li> </ul>	<ul style="list-style-type: none"> <li>• Chlorine and pH levels need adjustment.</li> </ul>	<ul style="list-style-type: none"> <li>• Super chlorinate with shock treatment. Correct pH to your pool store's recommended level.</li> <li>• Vacuum pool bottom.</li> <li>• Maintain proper chlorine level.</li> </ul>
<b>COLORED WATER</b>	<ul style="list-style-type: none"> <li>• Water turns blue, brown, or black when first treated with chlorine.</li> </ul>	<ul style="list-style-type: none"> <li>• Copper, iron or manganese in water being oxidized by the added chlorine. Common.</li> </ul>	<ul style="list-style-type: none"> <li>• Adjust pH to recommended level.</li> <li>• Run filter until water is clear.</li> <li>• Replace cartridge frequently.</li> </ul>
<b>SUSPENDED MATTER IN WATER</b>	<ul style="list-style-type: none"> <li>• Water is cloudy or milky.</li> </ul>	<ul style="list-style-type: none"> <li>• "Hard water" caused by pH level being too high.</li> <li>• Chlorine content is low.</li> <li>• Foreign matter in water.</li> </ul>	<ul style="list-style-type: none"> <li>• Correct pH. Check with pool dealer for water treatment.</li> <li>• Check for proper chlorine level.</li> <li>• Clean or replace your filter.</li> </ul>
<b>CHRONIC LOW WATER LEVEL</b>	<ul style="list-style-type: none"> <li>• Level is lower than on previous day.</li> </ul>	<ul style="list-style-type: none"> <li>• Rip or hole in pool liner or hoses. Tighten caps.</li> </ul>	<ul style="list-style-type: none"> <li>• Repair with patch kit.</li> <li>• Finger tighten all caps.</li> </ul>
<b>SEDIMENT ON POOL BOTTOM</b>	<ul style="list-style-type: none"> <li>• Dirt or sand on pool floor.</li> </ul>	<ul style="list-style-type: none"> <li>• Heavy use, getting in and out of pool.</li> </ul>	<ul style="list-style-type: none"> <li>• Use Intex pool vacuum to clean bottom of pool.</li> </ul>
<b>SURFACE DEBRIS</b>	<ul style="list-style-type: none"> <li>• Leaves, insects etc.</li> </ul>	<ul style="list-style-type: none"> <li>• Pool too close to trees.</li> </ul>	<ul style="list-style-type: none"> <li>• Use Intex pool skimmer.</li> </ul>

## POOL MAINTENANCE & DRAINAGE

**⚠ CAUTION** ALWAYS FOLLOW THE CHEMICAL MANUFACTURER'S DIRECTIONS, AND THE HEALTH AND HAZARD WARNINGS.

**Do not replenish chemicals in pool while pool is occupied. Skin or eye irritations may occur.** Concentrated chlorine solutions may damage the pool liner. In NO event shall Intex Recreation Corp., Intex Development Co. Ltd., their related companies, authorized agents and service centers, retailers or employees be liable to the buyer or any other party for the costs associated with the loss of pool water, chemicals or water damage. **Keep spare filter cartridges on hand. Replace cartridges every two weeks. We recommend that a Krystal Clear™ Intex Filter Pump be used with all of our above-ground-pools.**

**EXCESSIVE RAIN:** To avoid damage to the pool, immediately drain rain water that causes the water level to be higher than the maximum.

### How to Drain Your Pool and Long Term Storage

1. Check local regulations for specific directions regarding disposal of swimming pool water.
2. Check to make sure that the drain plug inside the pool is plugged in place.
3. Remove the cap from the drain valve on the outside pool wall.
4. Attach the female end of the garden hose to the patented hose adapter.
5. Place the other end of the hose in an area where the water can be safely drained away from the house.
6. Attach the hose adapter to the drain valve. **NOTE: The adapter will push the drain plug open inside the pool and water will start to drain immediately.**
7. Disconnect hose and adapter when finished.
8. Re-insert drain plug in drain valve on inside of pool for storage.
9. Replace drain cap on outside of pool.
10. Reverse set up instructions to disassemble the pool, and remove all plumbing parts.
11. Be sure pool and all parts are completely dry before folding, let it sit under the sun for an hour (**see drawing 5**). Sprinkle talcum powder to prevent vinyl from sticking together and to absorb any water you may have missed.
12. Create a square shape. Starting at one side, fold one-sixth of liner in on itself twice. Do the same on the opposite side (**see drawings 6.1 & 6.2**).
13. Once you have created two opposing folded sides, simply fold one over the other like closing a book (**see drawings 7.1 & 7.2**).
14. Fold two long ends to the middle (**see drawing 8**).
15. Fold one over the other like closing a book and compact the liner (**see drawing 9**).
16. Store the liner and accessories in a dry, temperature controlled, between 41 degrees Fahrenheit (5 degrees Celsius) and 100 degrees Fahrenheit (38 degrees Celsius), storage location.
17. The original packing carton can be used for storage.

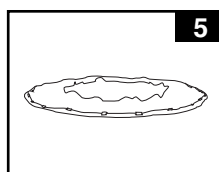

5

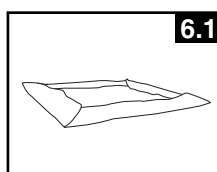

6.1

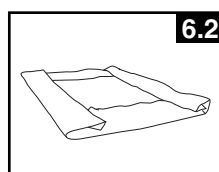

6.2

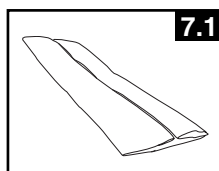

7.1

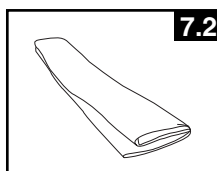

7.2

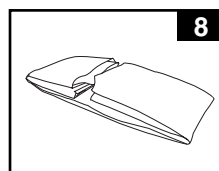

8

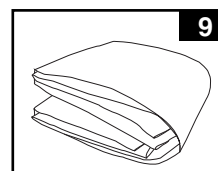

9

## STORAGE & WINTERIZING

### Winterizing your Above Ground Pool

Your pool can be easily emptied and stored in a safe place during the winter. However, many people choose to leave their pool up year round. In areas where freezing temperatures occur, there is risk of ice damage. It is recommended to drain, disassemble and store the pool in a safe place when temperatures drop below 41 degrees Fahrenheit (5 degrees Celsius). See "How To Drain Your Pool" section.

1. Clean pool water thoroughly (If Easy Set Pool or Oval Frame Pool make sure the top ring is properly inflated).
2. Remove the skimmer (if applicable) or any accessories attached to the threaded strainer connector. Replace strainer grid if necessary. Be sure all accessories parts are clean and completely dry before storage.
3. Plug the Inlet and Outlet fitting from the inside of the pool with the plug provided (sizes 16' and below). Close the Inlet and Outlet Plunger Valve (sizes 17' and above).
4. Remove the ladder (if applicable) and store in a safe place. Be sure the ladder is completely dry before storage.
5. Remove the hoses that connect the pump and filter to the pool.
6. Add appropriate winter chemicals. Consult your local pool dealer as different regions vary greatly.
7. Cover pool with Intex Pool Cover. **IMPORTANT: INTEX POOL COVER IS NOT A SAFETY COVER.**
8. Clean and drain pump, filter housing and hoses. Remove and discard old filter cartridge (keep a spare cartridge available for next season).
9. Bring pump and filter parts indoors and store in a safe and dry area, preferably between 41 degrees Fahrenheit (5 degrees Celsius) and 100 degrees Fahrenheit (38 degrees Celsius).

## GENERAL AQUATIC SAFETY

**Water recreation is both fun and therapeutic. However, it involves inherent risks of injury and death. To reduce your risk of injury, read and follow all product, package and package insert warnings and instructions. Remember, however, that product warnings, instructions and safety guidelines cover some common risks of water recreation, but do not cover all instances or risk and or danger.**

**For additional safeguards, also familiarize yourself with the following general guidelines as well as guidelines provided by nationally recognized Safety Organizations:**

- Demand constant supervision.
- Learn to swim.
- Take the time to learn CPR and first aid.
- Instruct anyone who is watching your children about potential pool hazards and about the use of protective devices such as locked doors, barriers, etc.
- Teach children what to do in case of an emergency.
- Always use common sense and good judgement when enjoying any water activity.
- Supervise, Supervise, Supervise.

For service questions or to order replacement parts, please contact the appropriate office listed below or visit [www.intexdevelopment.com](http://www.intexdevelopment.com) for answers to most frequently asked questions.

AREAS	LOCATION	AREAS	LOCATION
• ASIA	INTEX DEVELOPMENT CO. LTD. 8TH FLOOR, DAH SING FINANCIAL CENTRE, 108 GLOUCESTER ROAD, WANCHAI, HONG KONG TEL: 852-28270000 FAX: 852-23118200 E-mail: <a href="mailto:xmservicesupport@intexcorp.com.cn">xmservicesupport@intexcorp.com.cn</a> Website: <a href="http://www.intexdevelopment.com">www.intexdevelopment.com</a>	• CHILE / ARGENTINA / PERU / URUGUAY	COMEXA S.A SAN IGNACIO 0201, PARQUE INDUSTRIAL PORTEZUELO, QUILICURA, SANTIAGO, CHILE TEL: 56-2-339 9000 FAX: 56-2-339 9022 E-mail: <a href="mailto:generalsilfa@silfa.cl">generalsilfa@silfa.cl</a>
• EUROPE	INTEX TRADING B.V. POSTBUS 1075, 4700 BB ROSENDAAL, THE NETHERLANDS TEL: 31-(0)165-593939 FAX: 31-(0)165-593939 E-mail: <a href="mailto:service@intexcorp.nl">service@intexcorp.nl</a> Website: <a href="http://www.intexcorp.nl">www.intexcorp.nl</a>	• SAUDI ARABIA	SAUDI ARABIAN MARKETING & AGENCIES CO. LTD. PRINCE AMIR MAJED STREET, AL-SAFA DISTRICT, JEDDAH, KINGDOM OF SAUDI ARABIA TEL: 966-2-693 8496 FAX: 966-2-271 4084 E-mail: <a href="mailto:abid.syed@samaco.com.sa">abid.syed@samaco.com.sa</a> Website: <a href="http://www.samaco.com.sa">www.samaco.com.sa</a>
• FRANCE	INTEX SERVICE (FRANCE) SAS 52, ROUTE NATIONALE 39190 BEAUFORT, FRANCE TEL: 08 90 71 20 39 (0.15 TTC/min) FAX: 03 84 25 18 09 E-mail: <a href="mailto:sav@intexcorp.com.fr">sav@intexcorp.com.fr</a> Website: <a href="http://www.intex.fr">www.intex.fr</a>	• AUSTRIA	STEINBACH GMBH AUSTRIA AISTINGERSTRASSE 2 4311 SCHWERTBERG TEL: 0800 468397665 FAX: 07262 61439-0 E-mail: <a href="mailto:service@intexcorp.at">service@intexcorp.at</a> Website: <a href="http://www.intexcorp.at">www.intexcorp.at</a>
• GERMANY	STEINBACH GMBH GERMANY AN DER WELLE 4 60322 FRANKFURT TEL: 0800 468397665 FAX: 07262 61439-0 E-mail: <a href="mailto:service@intexcorp.de">service@intexcorp.de</a> Website: <a href="http://www.intexcorp.de">www.intexcorp.de</a>	• CZECH REPUBLIC / EASTERN EUROPE	INTEX TRADING S.R.O. BENESOVSKA 23, 101 00 PRAHA 10 CZECH REPUBLIC TEL: 420-2-717 32247 FAX: 420-2-673 12552 E-mail: <a href="mailto:info@intexcorp.cz">info@intexcorp.cz</a>
• ITALY	A & A MARKETING SERVICE OFFICE: VIA DEI MESTIERI 8, 20049 CONCOREZZO, MILANO - ITALY TEL: 39-039-6886260 FAX: 39-039-6043603 E-mail: <a href="mailto:intex@neamarketingservice.com">intex@neamarketingservice.com</a> Website: <a href="http://www.intexitalia.com">www.intexitalia.com</a>	• BELGIUM	N.V. NICOTOY S.A. MOESKROENSESTEENWEG 383 C, 8511 AALBEKE TEL: 0800 92088 FAX: 32-56.20.37.61 E-mail: <a href="mailto:intex@nicotoy.be">intex@nicotoy.be</a>
• UK	WAREHOUSE: C/O ALVI, VIALE DELLA REPUBBLICA 10 - 27100 PAVIA - ITALY	• DENMARK	K.E. MATHIASSEN A/S SINTRUPVEJ 12 DK-8220 BRABRAND DENMARK TEL: +45 89 44 22 00 FAX: +45 86 24 02 39 E-mail: <a href="mailto:intex@keleg.dk">intex@keleg.dk</a>
• SWITZERLAND	TOY BROKERS LTD MARKETING HOUSE, BLACKSTONE ROAD HUNTINGDON, CAMBS. PE29 6EF. UK TEL: 01480 414361 FAX: 01480 414761 E-mail: <a href="mailto:sales@toybrokers.com">sales@toybrokers.com</a> Website: <a href="http://www.toybrokers.com">www.toybrokers.com</a>	• SWEDEN	LEKSAM AB BRANDSVIGSGATAN 6, S-262 73 ÄNGELHOLM, SWEDEN TEL: +46 431 44 41 20 FAX: +46 431 190 35 E-mail: <a href="mailto:kundtjanst@leksam.se">kundtjanst@leksam.se</a>
• SPAIN / PORTUGAL	GWM AGENCY GARTEN-U. WOHNMÖBEL RÄFFELSTRASSE 25 POSTFACH CH-8045 ZÜRICH/SWITZERLAND TEL: + 41 - (0)900 - 455 456 FAX: 41 44 455 50 65 E-mail: <a href="mailto:gwm@gwm.ch">gwm@gwm.ch</a> Website: <a href="http://www.gwm.ch">www.gwm.ch</a>	• NORWAY	NORSTAR AS PINDSLEVEIEN 1 N-3221 SANDEFJORD NORWAY TEL: +47 33 48 74 10 FAX: +47 33 48 74 11 E-mail: <a href="mailto:intex@norstar.no">intex@norstar.no</a>
• AUSTRALIA	KOKIDO BVI LIMITED C/PLOMO 5-7, NAVE 19 POLÍGONO INDUSTRIAL AIMAYR SAN MARTIN DE LA VEGA 28330 MADRID SPAIN TEL: 34-90-2351045 FAX: 34-91-6912709 E-mail: <a href="mailto:belen@kokido.com">belen@kokido.com</a> E-mail: <a href="mailto:info@kokido.com">info@kokido.com</a>	• FINLAND	NORSTAR OY RUUKINTIE 20 FIN-02330 ESPOO FINLAND TEL: +358 9 8190 530 FAX: +358 9 8190 5335 E-mail: <a href="mailto:info@norstar.fi">info@norstar.fi</a>
• NEW ZEALAND	HUNTER OVERSEAS PTY LTD LEVEL 1, 225 BAY STREET, BRIGHTON, VICTORIA AUSTRALIA TEL: 61-3-9596-2144 or 1800-224-094 FAX: 61-3-9596-2188 E-mail: <a href="mailto:enquiries@hunteroverseas.com.au">enquiries@hunteroverseas.com.au</a>	• RUSSIA	LLC BAUER KIEVSKAYA STR., 20, 121165 MOSCOW, RUSSIA TEL: 095-249-9400/8626/9802 FAX: 095-742-8192 E-mail: <a href="mailto:intex@rdm.ru">intex@rdm.ru</a> Website: <a href="http://www.intex.su">www.intex.su</a>
• MIDDLE EAST REGION	HAKA NEW ZEALAND LIMITED UNIT 5, SENTINEL PARK, 25 AIRBORNE ROAD, ALBANY PO BOX 302171, NORTH HARBOUR, AUCKLAND 1330 NEW ZEALAND TEL: 649-4159213 FAX: 649-4159212 E-mail: <a href="mailto:geoff@hakanz.co.nz">geoff@hakanz.co.nz</a>	• POLAND	KATHAY HASTER UL. LUTYCKA 3, 60-415 POZNAN TEL: +48 61 8498 381/380 FAX: +48 61 8474 487 E-mail: <a href="mailto:inx@kathay.com.pl">inx@kathay.com.pl</a>
• SOUTH AFRICA	FIRST GROUP TRADING AL MOOSA GROUP BUILDING, 1ST FLOOR, OFFICE 102 & 103, UMM HURAIK ROAD, KARAMA, DUBAI, UAE TEL: 00971-4-3373322 FAX: 00971-4-3375115 E-mail: <a href="mailto:info@firstgrouptrading.com">info@firstgrouptrading.com</a> Website: <a href="http://www.firstgrouptrading.com">www.firstgrouptrading.com</a>	• HUNGARY	RECONTRA LTD. H-1113 BUDAPEST, DARÓCZI ÚT 1-3, HUNGARY TEL: +361 372 5200/113 FAX: +361 209 2634 E-mail: <a href="mailto:gizi@recontra.hu">gizi@recontra.hu</a>
	WOOD & HYDE 15-17 PACKER AVENUE, INDUSTRIA 2, CAPE TOWN, SOUTH AFRICA 7460 TEL: 27-21-0800-204-692 FAX: 27-21-505-5600 E-mail: <a href="mailto:ygoldman@thumb.co.za">ygoldman@thumb.co.za</a>	• BRAZIL	KONESUL MARKETING & SALES LTDA RUA INÁCIO BORBA, 835 - CEP. 04715-020, CHÁCARA SANTO ANTONIO - SÃO PAULO - SP - BRASIL TEL: 55 (11) 5183 8866 FAX: 55 (11) 5183 8866 E-mail: <a href="mailto:konesulintex@uol.com.br">konesulintex@uol.com.br</a>